

IBEX ELECTRONIC SPEED CONTROLLER

USER MANUAL *FIRMWARE VERSION 1.09*

The IBEX product line represents advanced speed controllers for use exclusively in RC airplane models. With integrated telemetry and various possibilities of optional user configuration, the controllers offer high efficiency, low weight and precise motor control. The integrated high-power BEC, offering 15Amps of continuous current, is suitable even for the most demanding applications. The full power of the BEC is available at any battery voltage within the controller specification (6-51V).

FEATURES

- Small dimensions combined with high power motor control.
- High power BEC offers 15A continuous current (30A max). BEC overcurrent and overtemperature protection included.
- BEC voltage setting in 0.1V steps.
- Over- and undervoltage protection, overtemperature protection, motor-stall protection.
- Configurable current limiter.
- Safety shutdown when the throttle impulse is lost.
- Configurable acceleration, timing, electromagnetic brake, motor reversing etc.
- Low acoustic noise due to high frequency switching.
- Automatic telemetry detection: Duplex EX, Hott, MSB, PowerBox P2Bus, S.Bus2. Alternative firmware with Spektrum SRXL2 telemetry support.
- Telemetry (RC system dependent): voltage, current, power, capacity, temperature, RPM, energy.
- Telemetry min/max values are logged.
- Configuration through the transmitter, MAV Manager PC software or external terminal (JETIBOX/ SMART-BOX).
- Firmware updates via USB interface.
- Languages: CZ/DE/EN/FR/IT.

	IBEX-55 SBEC	IBEX-65 SBEC	IBEX-85 SBEC	IBEX-115 SBEC	IBEX-155 SBEC
Dimensions	75x29.5x10mm	75x29.5x12mm	80x30x13.5mm	88x32x14mm	88x32x14mm
Weight incl. cables	63g	68g	81g	90g	90g
Continuous current	50A*	60A*	80A*	110A*	150A*
Peak current	80A/2s*	100A/2s*	120A/2s*	170A/2s*	200A/2s*
Supply voltage	6 – 51V	6 – 51V	6 – 51V	6 – 51V	6-27V
LiPo cells	2 – 12	2 – 12	2 – 12	2 – 12	2 – 6
LiFe cells	3 – 14	3 – 14	3 – 14	3 – 14	3 – 7
Cables battery/motor	2.5mm ² /2.5mm ²	2.5mm ² /2.5mm ²	4mm ² /2.5mm ²	4mm ² /4mm ²	6mm ² /4mm ²
Anti-spark circuit	No				
Recommended connectors	XT60 (60A)	XT60 (60A)	G4 (75A), XT90 (90A)	G5.5 (150A), XT90 (90A)	G5.5 (150A)
Temperature range	-10÷110°C				
PWM frequency	20kHz				
Operating current	60mA				
Standby current	4mA				
Propeller positioning	No	With additional Hall-sensor			
Telemetry	Duplex EX, Multiplex MSB, Futaba S.Bus2, Graupner Hott, PowerBox P ² Bus, Spektrum SRXL2™				
Status LED	Yes				
Active freewheeling	Yes				
BEC continuous output current	12A*		15A*		
BEC peak current	25A/2s*		30A/2s*		
BEC voltage setting	5.5 – 8.4V (0.1V steps)				
Optical isolation	No				
Maximum RPM	> 300 000 eRPM (2-pole motor)				
External switch voltage	Approx. 10V				
External switch max. current	30mA				

*) Specified values are valid in case sufficient continuous airflow is provided.

INSTALLATION

Fasten the controller in your model using Velcro or double-sided adhesive tape. Connect the motor and receiver according to the schematic below. You may connect the motor cables in arbitrary order, as changing direction is done by exchanging any of the two cables (alternatively also by the “Direction” parameter in the configuration). Turn on the transmitter. Now you can plug in the main flight pack and turn on the speed controller with the receiver attached.

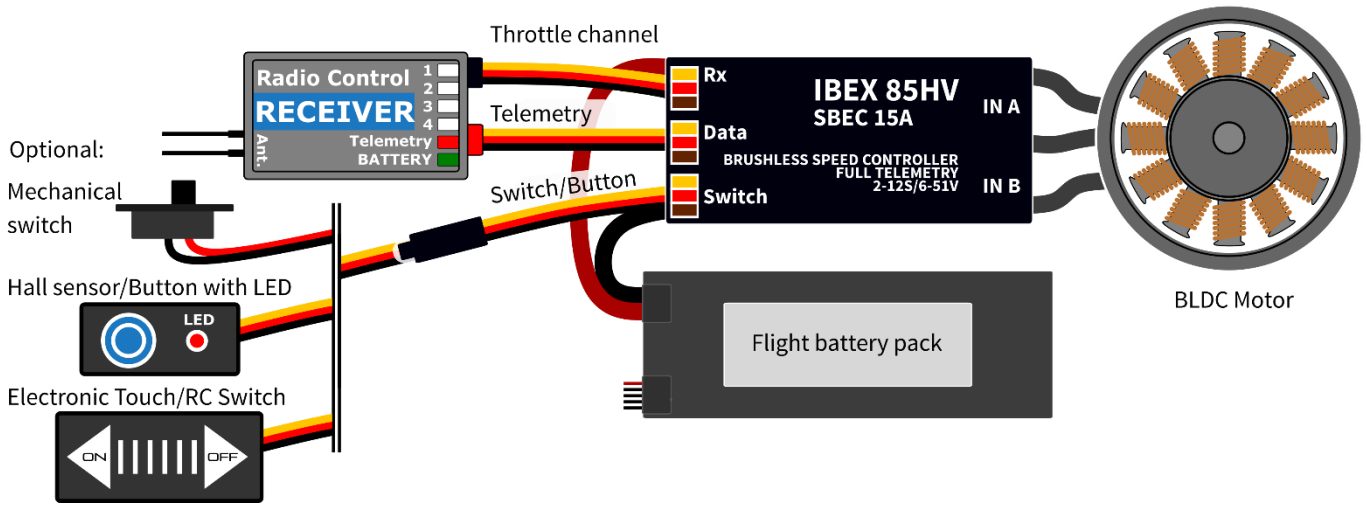

Note: The red LED on the controller will light up for two seconds to indicate proper initialization. After the correct throttle impulse is detected (meaning off position), the controller plays a predefined melody. Now it's ready to fly. The controller will enter standby mode on behalf of the switch or button command. The type of used switching element is defined in the controller configuration. If there is no switching element connected (keeping “Mechanical Switch” in the settings), the controller is always turned on.

Warning: Always use brand new, high quality connectors and make sure that the cables are soldered perfectly. Any possibility of losing connection during motor run represents a risk of damaging your electronics.

Warning: If you start the controller for the first time, or make any significant changes in the setup, please make sure that the propeller is removed from the motor shaft.

Warning: Always disconnect batteries after the flight session ends. Even if the speed controller is turned off by the switch, it still draws some small current. This could result in a completely drained battery within a few days or weeks.

Note: If your flight pack voltage is greater than 25V (6S LiPo) we recommend using the power connectors with integrated antispark mechanism. For example, the XT90 connectors with integrated antispark can be used.

CONTROLLER MODE

It is possible to choose from three basic controller modes:

- Normal (ramped) – the preconfigured acceleration time is always applied when accelerating. This is a default mode for major use.
- Fast mode – the preconfigured acceleration is applied only when spinning up from zero revolutions. After that, a minimum possible delay is used (0.2s for zero-to-full throttle response).
- Normal with reverse – behaves similarly to the Normal mode. In addition, you can choose a throttle reversing channel that will control the motor direction during flight.

THROTTLE INPUT SIGNAL

The controller expects positive impulses from the receiver with maximum refresh rate up to 400Hz. By default, with automatic endpoints selected, the controller will work with vast majority of RC systems. In such case, a minimum throttle impulse is read after startup and the maximum power is dynamically adjusted as soon as you apply full throttle for the first time.

In case you need exact points on your transmitter stick, where the motor starts and where full throttle is, you can configure manual endpoints as well.

Note: The controller waits for throttle-low position after startup and also every time the motor is stopped due to any error condition. If the throttle stick is not at the correct position during startup, the ESC plays a warning tone.

MOTOR SETTINGS

It is possible to configure many of the motor parameters, including acceleration, timing, motor gear ratio or number of poles. The gear ratio and number of poles are important for telemetry to measure the motor speed correctly.

Acceleration influences the motor response on the throttle channel. By decreasing the acceleration value, the motor response gets faster, providing more “locked-in” feeling. However, the motor consumes more current and the controller generates more heat. We recommend the default acceleration 1.0s for majority of model types, including electric gliders, scale models, EDFs etc. For 3D aerobatic flight you might go down to 0.5s or even less (with care). For the fastest motor response, you may also set the “Fast controller mode” in the Common Settings.

Timing is defined by the motor type and it is usually recommended by the motor manufacturer. It also influences the motor power and current consumption. Higher timing can increase the motor power but care must be taken not to overload the system.

- Automatic timing: The timing is continuously adjusted by the internal algorithm. This is a universal solution compatible with most motor types.
- Timing 0° - 10°: Recommended for inrunners.
- Timing 15° - 20°: Recommended for most outrunners. It offers good power and efficiency combination.
- Timing 25° - 30°: The high torque motors with many poles require the highest timing.

Motor type should be modified only in some specific cases where it is necessary by the application. There are three options available:

- “Standard” motor type – recommended for most motor types and applications.
- “High torque” – if you have problems with motor synchronization during fast acceleration, use this mode. Preconditions: large outrunner with more than 20 poles, heavy propeller, large current peaks. We also recommend increasing timing to more than 20°.
- “High speed” – use this mode if your power setup exceeds 250 000 eRPM (revolutions per minute calculated for a 2-pole motor).

Startup power influences the first few motor revolutions. If you are not satisfied with the automatic mode, you can set the motor start to be more aggressive (positive values), or as smooth as possible (negative values).

BRAKE CONFIGURATION

The electromagnetic brake is a standard feature of all ESCs used in electric glider models. The IBEX controller offers several additional parameters to fine tune the braking function. You can use one of the preconfigured brake settings, or you can specify all the parameters as you wish.

Brake options:

- Off: The propeller spins freely without braking.
- Soft: Transition from zero to full braking force in 1.0s.
- Medium: Transition to full braking force in 0.7s.
- Hard: Transition from 50% to 100% braking force in 0.5s.
- Manual: You can specify all brake parameters manually:
 - Start power – braking force applied from the first moment of applying the brake.
 - End power – braking force applied after the transition time elapses (usually the full braking force that stops the motor completely).
 - Transition – time between brake start power and brake end power. During this time, the braking force continuously transits from start to end power.
 - Wait time – time between unpowering the motor and applying the brake. During this time the motor spins freely without power.

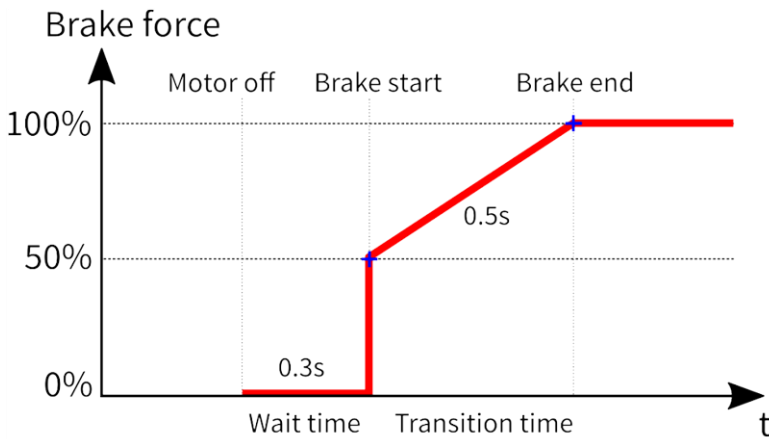

Example: Motor brake with the following parameters: Start power = 50%, End power = 100%, Transition = 0.5s, Wait time = 0.3s.

BEC VOLTAGE AND SETTING

In the Common Setting menu, you are able to modify the BEC voltage very precisely in steps of 0.1V. The controller contains a very powerful BEC which is able to deliver up to 15Amp continuous current. However, in case of high power setup, sufficient cooling airflow must be provided. Connecting both *Telemetry* and *Throttle* cables to the receiver is recommended to provide high current throughput.

Warning: Always set the BEC voltage according to the rating of the attached electronics, including receivers, sensors and servos. Never exceed the voltage limits.

BACKUP BATTERY

In case you need a small buffer battery for covering voltage spikes of the attached servos, you can specify its presence in the *Common Setting - Backup battery* menu. After setting the battery type it is necessary to remove all power supplies from the controller and then reconnect them. Possible options:

- “No” (default) – the buffer battery is not present and the BEC voltage is set according to the value set in the configuration. No external power supply shall be connected to the receiver side, otherwise the BEC won't turn on.
- “2S LiPo 8.4V” – an external power supply with maximum voltage 8.4V is expected on the receiver side (see the picture). The controller won't initialize itself if the backup battery voltage is outside the limits (or not connected). The BEC voltage will be set automatically according to the backup battery, so that there is no risk of uncontrolled currents.
- “2S LiFe 7.2V” – an external power supply with maximum voltage 7.2V is expected on the receiver side. The behavior is similar to the case of 2S LiPo.

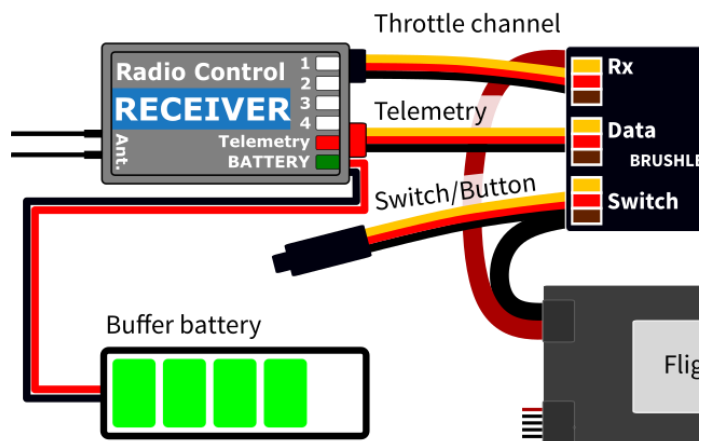

EXTERNAL SWITCH

The IBEX ESC allows you to install an external switch if needed. By default the switch is not present, so that the speed controller/BEC turns on immediately after connecting the flight battery.

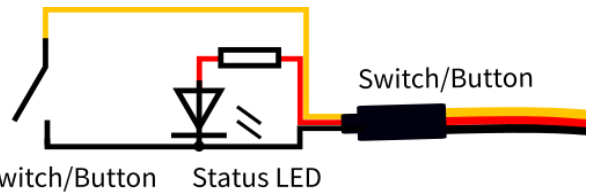

You can specify the type of switching element in the *Common Setting – Switch Type*:

- Mechanical (default) – the switch shorts the yellow (signal) and brown (ground) wires of the *Switch/Button cable*. An inverted logic is used, so that the ESC stays turned on if the switch is left open.
- Button/Hall – first long press turns on the ESC; second long press turns it off. The LED indicates on/off state and blinks if the magnet (or button press) is detected. The Hall sensor can be bought as an ESC accessory.
- Electronic – allows you to install an external electronic switch (Touch Switch, RC Switch etc.). In this case, the switching device is always powered and the logic level of the signal wire specifies the on/off state to the controller.

Note: Please pay attention to the parameters of an external switch before connecting. The signal wire uses a 3.3 Volt logic with a weak pull-up. The power supply from the ESC is rated 10V with maximum current 30mA.

PROPELLER POSITIONING

The positioning feature allows moving the motor/propeller to the exact position required for safe landing, or which is just comfortable for further flying. With just a few external components (Hall-sensor and a small magnet) you can enable this feature and prevent the risk of damaging your propeller during landing. The magnet needs to be properly fixed to the rotating part (either motor or the propeller), and the Hall-sensor has to be located in the fuselage, so that the magnet matches the Hall-sensor at the target propeller position. After enabling the positioning feature in the menu (Prop Position = *Hall Sensor*), set also the Positioning PWM, so that the motor spins slowly but smoothly. You may also change the duration of actively held motor position (Position Hold Time) which is applied after the correct position is found. The position-hold feature is useful in case of retractable engine since it doesn't allow propeller to be moved while retracting.

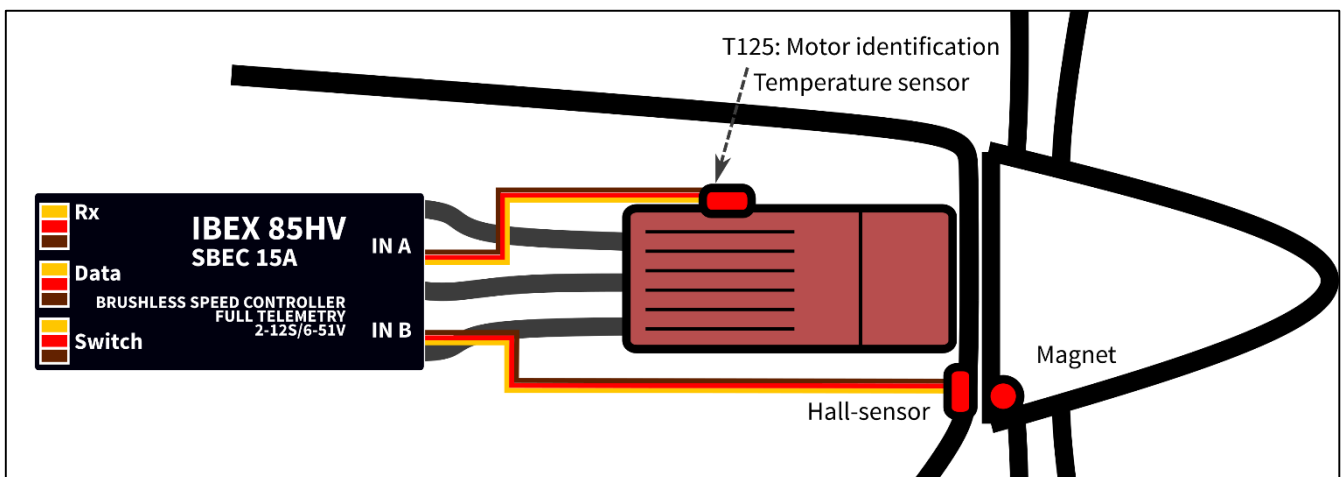

Connect the Hall-sensor of the propeller positioning function to the **IN-B** port of the controller.

Note: Use a high quality CA or Epoxy glue to fix the magnet in the rotating part. You can also drill a small hollow in the spinner and fix the magnet in it.

Warning: Do not use higher PWM than necessary otherwise the motor may overheat. Generally use as low PWM as possible so that the motor holds its position reliably. Check the current consumption using the telemetry.

MOTOR IDENTIFICATION

Some motor brands contain an integrated temperature sensor compatible with the IBEX speed controller. This sensor (T125-ID) might be used as a standalone telemetry sensor with Duplex/Hott/S.Bus2 telemetry support. Alternatively, the sensor can be directly connected to the Input port „A“ of the controller (see the picture above). From this moment on, the IBEX controller will know the basic motor parameters (minimum acceleration, recommended timing, gear ratio, number of poles...) and motor temperature as well. Some parameters are adjusted automatically (gear ratio, poles), the other settings are configured after resetting the controller to factory defaults. Connect the motor-identification sensor into the **IN-A** port of the controller.

ACTIVE FREEWHEELING

“Active freewheeling” or “Active braking” is a feature of the speed controller that reduces heat generated by the ESC during partial load operation. This mode is useful for aerobatic pilots who want not only fast acceleration, but also rapid deceleration. The motor follows throttle stick input in both ways and the pilot feels more “locked-in”.

CURRENT LIMITER

The current limiter is a part of safety controller features. It doesn't stop the motor but rather continuously monitors the immediate current consumption and adjusts the motor power. You can enable this feature, specify the maximum allowed current and the ESC will reduce the motor power immediately as soon as the current threshold is exceeded. After the current returns back to the safe level, the motor power is restored.

BATTERY PROTECTION

The integrated battery protection is based on undervoltage detection and reducing motor power, alternatively shutting down the motor completely. You are free to set the number of cells (or leave automatic detection) and low voltage threshold per cell. Supported battery types are NiXX (1.2V), LiFe (3.6V max) and LiIo/LiPo (4.2V max).

STATUS CODES

The status codes are shown on the screen (JETIBOX/SMART-BOX) if any kind of error condition occurs. If any status code is set, the red LED continuously flashes.

Available status codes:

- Low voltage (UL): The battery voltage got below the threshold specified in the battery protection menu and the controller either reduced the maximum power, or shut down the motor completely.
- High voltage (UH): In case you use a weak battery or wall power supply, the voltage might rise above the initial level during braking. In such case the alarm is set and all braking functions are disabled.
- High current (IH): The current got higher than the maximum peak current defined in the product specification (120A for IBEX-85).
- High temperature (T100, T110, T120): The temperature got above the safety threshold level. The numerical value specifies maximum detected temperature and safety protocol which has been applied.
- Commutation error (COM): A synchronization error has been detected during the motor operation. It usually occurs when the motor stops abruptly, or in case of very fast acceleration for some specific setups. This error could mean a serious issue in the motor-controller installation.

MOTOR DIRECTION REVERSING

The motor reverse feature is available for RC systems with bidirectional bus support (EX Bus, P²Bus, SRXL2, S.Bus2). To control the motor direction you need to define an additional channel transferred through the bus system. Both cables (red and black) of the IBEX speed controller must be properly linked the receiver.

First, you need to create an additional channel on you transmitter to control the motor direction. This channel should be operated by a two-position switch.

Futaba/Spektrum:

Use one the AUX channels and remember the channel number. It is not necessary to use just the channels available on your receiver since the RC systems usually offer more channels over the bus than the physical number of receiver ports.

Example: If you use Spektrum NX6 and a 6-channel receiver, you may still use the channel No. 7 (AUX2) to control the reversing feature over the bus.

JETI:

Create a new model function in the *Model - Functions Assignment* menu and assign a spare two-position switch. After that, in the *Model - Servo Assignment* menu, assign the function to one of the receiver channels (1-16). Again, you may use the channels that are not directly available on the receiver outputs (e.g. 13-16) since they will be transferred through EX Bus without limitation.

PowerBox:

Create a new model function in the *Function menu* by pressing the “+” button and assign it a 2-position control switch. Choose one of the available servo output channels (1-16). The switch position will be transferred over the P²Bus to the speed controller.

To enable the motor reverse function in the controller, set the “Controller Mode” to “Normal/Reverse” and set the correct channel from the previous step. You may also play with the brake settings and *reverse wait time* under “Manual” brake type.

Check the function: As soon as you flip the direction switch, the controller activates braking, and after some short pause, the motor starts spinning in the opposite direction.

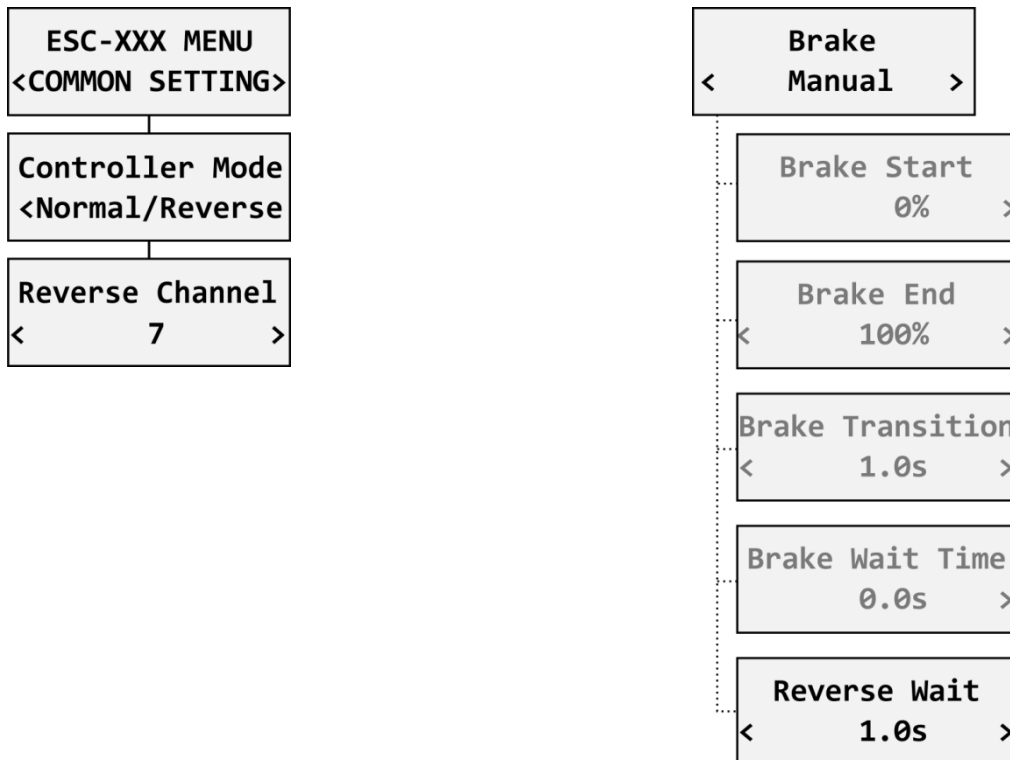

Note: The brake is always enabled in the “Normal/Reverse” mode. Even if you set the brake type to “Off”, the **Soft braking** will be applied.

TELEMETRY AND SETTINGS

Plug the red data cable into the sensor slot of the JETIBOX / SMART-BOX (or corresponding receiver). Power it up with a battery (4.5 - 8.4V). Now you can safely configure the controller using the arrows on the terminal. If you use an external (optional) switch connected to the ESC, please make sure that the controller is turned on.

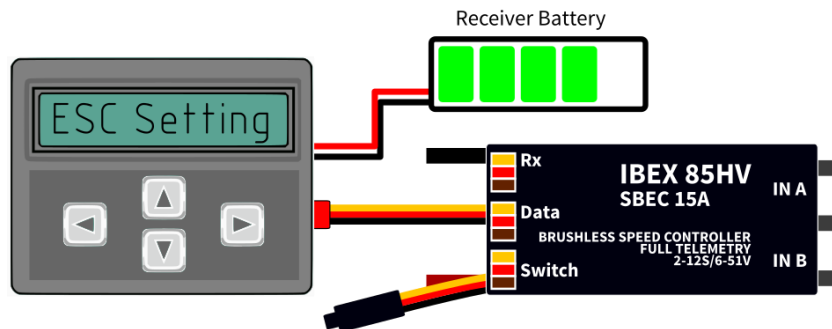

The IBEX ESC is compatible with JETIBOX programming. The JETIBOX menu is divided into five sections:

- **Actual values** – displays the latest telemetry values together with minimums and maximums.
 - Available telemetry: Voltage, current, capacity, RPM, power (percent), temperature.
 - If the motor chip ID is connected, also motor identification and temperature are shown.
 - Reset Min/Max - press left+right buttons together to reset all minimums and maximums.
- **Common settings** – basic settings of the controller
 - **Controller mode** – basic controller mode (normal or fast).
 - **Startup beep** – choose a melody played after the controller initialization.
 - **Standby beep** – you can activate short repeated beeps as an indication of a powered motor drive.
 - **Motor endpoints, motor start, motor full** – settings related to throttle input signal decoding.
 - **Capacity reset** – you can choose at which moment the capacity and consumed energy are reset.
 - **Power on** – the capacity is cleared after initialization. However, the capacity from the previous run is shown initially, until you start the motor.
 - **Voltage change** – the capacity is cleared after you connect a battery with similar (or greater) voltage compared to the maximum battery voltage from the previous run. This means that each time you connect a fully charged battery of the same chemistry and number of cells, the capacity will be cleared.
 - **Manual** – the capacity/energy is never cleared and you must perform the reset manually.
 - **Language** – you can choose the language of the JETIBOX screen.
- **Motor settings** – settings related to motor parameters.
 - **Direction, acceleration, timing, startup power, motor type, gear ratio, motor poles** – see the Motor Settings chapter.
 - **Brake related settings** – see the Brake configuration chapter.
 - **Prop position, positioning PWM, position hold time** – see the chapter Propeller positioning.
 - **Motor Enabled (0/1)** – motor operation can be enabled or disabled based on the logical state of the specific input “IN B.2” (connector pinout from left to right: 1 = Hall sensor input, 2 = Motor enable input, 3 = 3.3V, 4 = Ground).
 - **Freewheeling** – enables freewheeling/active braking motor operation.
- **Protection** – ESC and battery protection settings.
 - **Low battery** – behavior when the battery is discharged. Either set to slowly reduce the motor power, or shut down the motor immediately. The minimum safe voltage is based on number of cells (cell count) and voltage per cell.
 - **Limit current** – enable this feature to prevent high current peaks and system overload.
 - **Limit power at 100°C** – you can edit the maximum allowed PWM after the controller temperature exceeds 100°C. The model must be operable, but the temperature must not increase anymore.
- **Service** – In this menu you can view the device version and reset it to the default factory configuration.

JETIBOX Menu Structure

Available EX and P2Bus telemetry

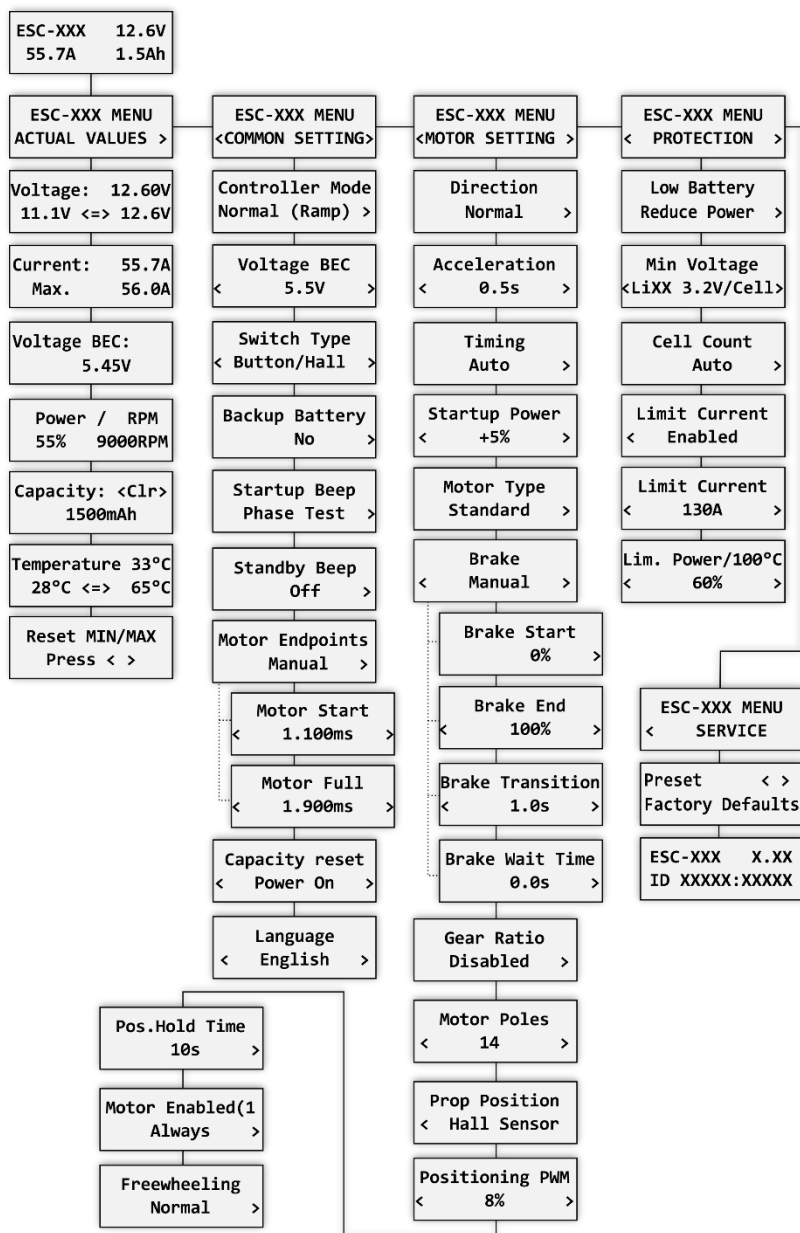

1. Battery voltage [V]
2. Motor current [A]
3. Capacity [mAh]
4. Speed [RPM]
5. PWM [%]
6. Power [W]
7. Running time [s]
8. Energy [Wmin] – useful feature for competitions where total energy is limited (F5B, F5D).
9. Temperature [°C]
10. External temperature [°C] – if the motor identification chip is connected, the ESC forwards motor temperature in its own telemetry.
11. Motor status:
 0 = Initial state,
 1 = motor running,
 2 = braking,
 3 = positioning started,
 4 = position found,
 5 = position error (prop out).
12. BEC voltage[V]

Graupner Hott Menu Structure

ESC-XXX VX.XX VOLTAGE 12.60V 11.1V / 12.6V CURRENT 55.7A MAX. 56.0A CAPACITY 1500mAh PWM 55% 9000RPM 1/11	ESC-XXX VX.XX TEMPERATURE 33°C 28°C / 65°C CLEAR CAPACITY >RESET MIN/MAX FACTORY DEFAULTS 2/11	ESC-XXX VX.XX >LANGUAGE English CONTROLLER MODE Normal (Ramp) VOLTAGE BEC 5.5V SWITCH TYPE Mechanical 3/11	ESC-XXX VX.XX >BACKUP BATTERY STARTUP BEEP No Phase Test STANDBY BEEP OFF 4/11	ESC-XXX VX.XX >CAPACITY RESET Power On MOTOR ENDPOINTS Manual MOTOR START 1.10ms MOTOR FULL 1.90ms 5/11	ESC-XXX VX.XX >DIRECTION Normal ACCELERATION 0.5s TIMING Auto STARTUP POWER Auto 6/11
ESC-XXX VX.XX >MOTOR TYPE Standard GEAR RATIO Off MOTOR POLES 14 7/11	ESC-XXX VX.XX >BRAKE Manual BRAKE START 0% BRAKE END 100% TRANSITION 1.0s WAIT TIME 0.0s 8/11	ESC-XXX VX.XX >FREEWHEELING Normal PROP POSITION Hall Sensor POSITIONING PWM 7% POS.HOLD TIME 10s 9/11	ESC-XXX VX.XX >MOTOR ENABLED (1) Always LOW BATTERY Reduce Power MIN VOLTAGE LiXX 3.2V/Cell 10/11	ESC-XXX VX.XX >CELL COUNT Auto LIMIT CURRENT Yes MAX. CURRENT 80A LIM.POWER/100°C 60% 11/11	

The IBEX controller is recognized by default as an “Air-ESC” sensor.

Futaba and Multiplex connection

Futaba and Multiplex systems do not offer wireless device configuration. The telemetry transmission is possible with the following fixed sensor slots:

	Futaba S.Bus2 slot	Note	Multiplex MSB slot
RPM	2	Choose RPM sensor on slot 2 .	6
Current	3	Choose SBS01C current sensor on slot 3 .	3
Voltage	4		2
Capacity	5		4
Temperature	6	Choose Temp125 sensor on slot 6 .	5
PWM (0-100%)	7	Choose Temp125 sensor on slot 7 .	-
Note	Manual detection in the menu Linkage – Sensor.		Automatically detected by the transmitter.

PowerBox telemetry

From version 1.09, the IBEX controller is able to recognize the PowerBox P²Bus telemetry protocol. Connect the Telemetry cable (red connector) to the P²Bus port of the receiver. The transmitter scans for attached sensors as soon as the receiver is powered up and the controller telemetry should be available within 2.5 seconds. After that you are free to assign the telemetry to any desktop widgets and alarms. Available telemetry is similar to the Duplex EX telemetry (see above). The controller configuration through the PowerBox transmitter is not available at the moment.

Spektrum integration

From version 1.06, the Spektrum telemetry support has been integrated in a special firmware version. This alternative firmware offers the SRXL2 telemetry and setting using the TextGen protocol. The IBEX controller is represented in the transmitter by two telemetry devices:

- “ESC” shows battery voltage, current, BEC voltage, ESC temperature, RPM and power output.
- “Flight Pack Capacity” sensor that shows the consumed battery capacity.

Connect the Throttle cable (black connector) to the *Thr* (1) receiver port. For proper telemetry/setting also connect the Telemetry cable (red connector) to the *Prog/SRXL2* receiver port. The controller normally delivers only numerical telemetry. The textual menu (TextGen) is available only after a special procedure is performed during startup:

- We assume the *Throttle* and *Telemetry* cables are connected correctly and the transmitter is turned on. Now push the throttle high.
- Turn on the ESC either by connecting the flight pack or by flipping the external switch.
- The motor will beep indicating detection of the high throttle impulse. After 3 seconds, another beep announces entering the programming menu.
- Now you may pull throttle low On the transmitter main screen scroll right to locate the TextGen menu. The motor will never start spinning if the textual menu is enabled. To enable normal motor operation, you have to leave the TextGen menu by choosing the “Exit” option on the first page.
- Navigation in the menu is provided by the transmitter sticks – elevator stick moves the cursor up/down and aileron stick changes the selected value.
- The configuration changes are saved immediately after any value is edited.

Note: Use the latest firmware version in your transmitter and receiver. For Spektrum NX, at least version 3.06 has to be installed. Recommended receivers: AR8360T, AR8020T, AR6610T, AR631T, AR637T...

1) Welcome page

```
ESC-XXX X.XX
      0RPM
12.6V 0.0A
>TELEMETRY
•COMMON SETTING
•MOTOR SETTING
•PROTECTION
•Factory Defaults
•Exit
```

2)
3)
4)
5)

2) Telemetry page

```
ESC-XXX X.XX
>Back
12.6V 0.0A
Max. 56.0A
      1500mAh
      33°C
28°... 65°C
•Clear Capacity
•Reset MIN/MAX
```

3) Common setting

```
ESC-XXX X.XX
>Back
•Language
  English
•Controller Mode
Normal (Ramp)
•Voltage BEC
  5.5V
•Switch type
  Mechanical
•Backup Battery
  No
•Startup Beep
  Phase Test
•Standby Beep
  Off
•Motor Endpoints
  Manual
•Motor Start
  1.10ms
•Motor Full
  1.90ms
•Capacity reset
  Power On
•Back
```

4) Motor setting

```
ESC-XXX X.XX
>Back
•Direction
  Normal
•Acceleration
  1.0s
•Timing
  Auto
•Startup Power
  Auto
•Motor Type
  Standard
•Gear Ratio
  Off
•Motor Poles
  14
•Brake
  Manual
•Brake Start
  0%
•Brake End
  100%
•Transition
  1.0s
•Wait Time
  0.0s
•Freewheeling
  Normal
•Prop Positioning
  Hall-Sensor
•Positioning PWM
  7%
•Pos.Hold Time
  10s
•Motor Enabled
  Always
•Back
```

5) Protection

```
ESC-XXX X.XX
>Back
•Low Battery
  Reduce Power
•Min Voltage
  LiXX 3.2V
•Cell Count
  Auto
•Limit Current
  Yes
•Max. Current
  80A
•Lim.Power/100°C
  60%
•Back
```

SAFETY INFORMATION

- Operate the IBEX controller always in dry environment and within the device limits stated in this guide. Never expose the device to excessive heat or cold outside the working area.
- Provide sufficient airflow to prevent controller overheating.
- Never exceed the maximum allowed operating voltage of the controller/motor.
- Do not increase the cable length between the controller and motor. In case you need to lengthen the wires between the controller and battery to more than 40cm (in total), solder some high capacity low-ESR capacitors (220-470uF) every 30cm in parallel to the power wires.
- Always use high quality connectors in good condition. Replace them if any visible sign of wearing appears.
- Always remove the propeller prior to making any changes in drive setup.
- Never disconnect the ESC from the battery while the motor is spinning.
- Do not remove the cover and heat sink from the device and do not try to implement any changes or modifications. This can lead to a total destruction and to the denial of any warranty claims.
- Always check the polarity of the connection. Never inverse the polarity – this could lead to total destruction.

FIRMWARE UPDATE

Firmware updates for the IBEX ESC are transferred from a PC via the USB interface. The required programs and files are available at www.mavsense.com.

Install the MAV Manager software and the USB drivers on your computer. Check the system requirements.

- 1) Make sure that the battery flight pack is disconnected and the IBEX ESC is unpowered.
- 2) Connect the USB interface to your PC, run MAV Manager - Updater and select the correct COM Port.
- 3) Connect the IBEX ESC according to the picture below – use the red (telemetry) port. The controller will be automatically detected.
- 4) Select the correct *.BIN file and press the Update button.

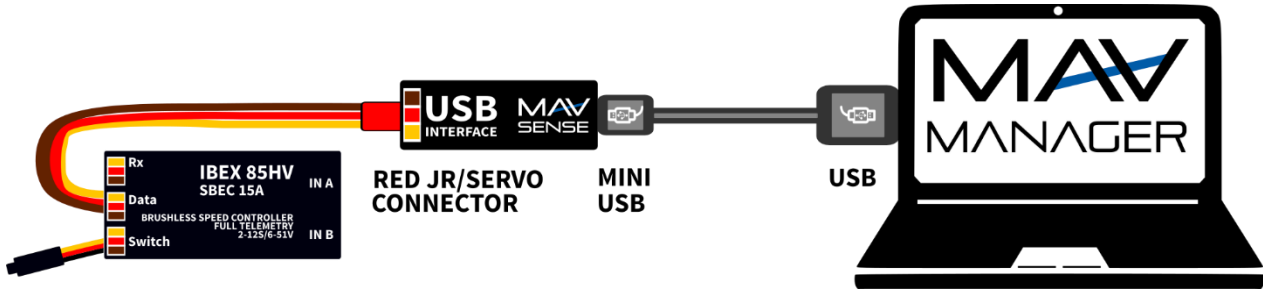

PC CONFIGURATION

It is possible to use the MAV Manager software (1.4.0 and later) to conveniently configure all controller settings, display real-time telemetry and make a backup of the configuration. The configuration menu contains four buttons in the top toolbar:

- **Refresh** – forces the configuration to be reloaded from the controller.
- **Import** – imports the settings from a file. If you have several speed controllers and want identical settings for all of them, simply import the same settings to each controller.
- **Export** – exports the settings from the controller to a file. You can easily create a backup configuration stored in your PC. After creating a backup, you may easily experiment with the controller settings and later revert back to the original configuration by pressing the “Import” button and choosing the original exported file.
- **Reset default** – resets the controller to factory defaults and reloads all the settings.

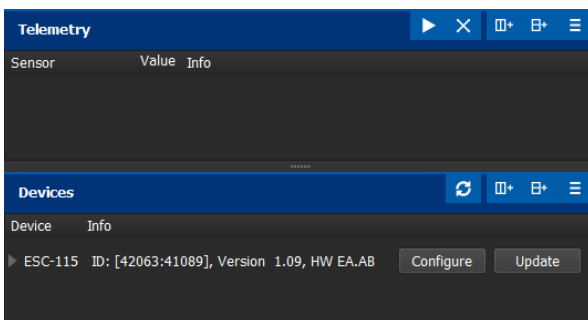

Connect the controller to your PC using the USB interface. The ESC will be automatically detected by the MAV Manager.

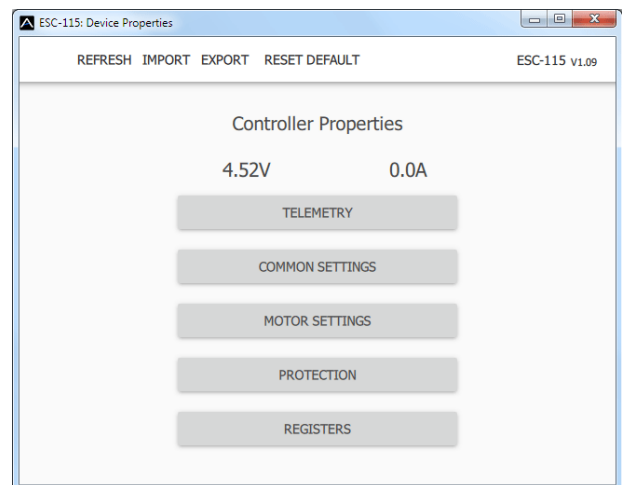

The controller properties are available after pressing the “Configure” button.

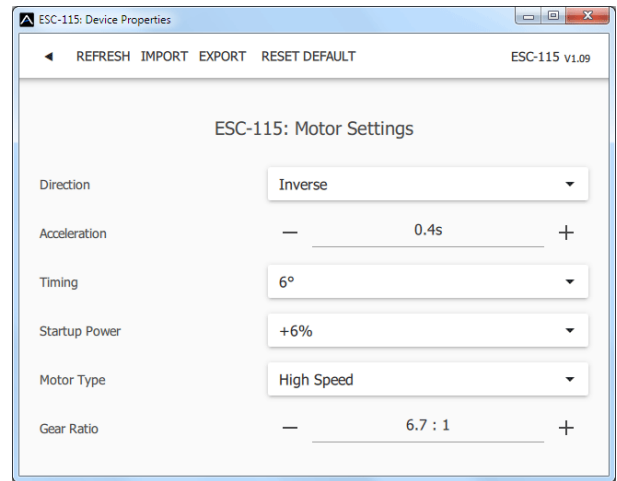
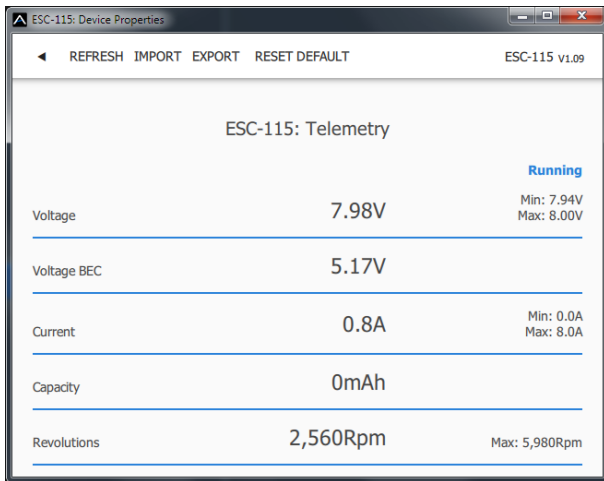

Real-time telemetry with min/max values. The MAV Manager is also able to create a log file from the real-time telemetry data, which can be viewed, analyzed, imported and exported.

Motor settings. Every time you make any change in the configuration, the new value is immediately transferred to the controller and saved to memory. There is no need for additional confirmation. For safety reasons, some parameters are only applied after the motor is stopped.

WARRANTY

We grant a warranty of 24 months from the day of purchase under the assumption that they have been operated in conformity with these instructions at recommended voltages and that they were not damaged mechanically. Warranty and post warranty service is provided by the manufacturer.



Distributor

GB: ESG-JETI-FIALA UK, B M Jones, 15 London Road, Hassocks, West Sussex, BN6 9NT, United Kingdom.
E-mail: sales@esoaringgadgets.co.uk | Website: www.esoaringgadgets.co.uk | Phone: 44(0)7740181861

Manufacturer

MAV Sense s.r.o.
E-mail: info@mavsense.com | Website: www.mavsense.com

Information on Disposal for Users of Waste Electrical & Electronic Equipment (private households)

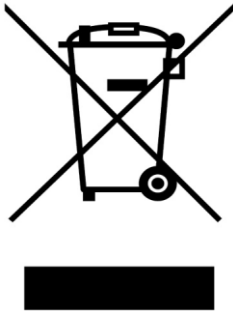

This symbol on the products and/or accompanying documents means that used electrical and electronic products should not be mixed with general household waste.

For proper treatment, recovery and recycling, please take these products to designated collection points, where they will be accepted on a free of charge basis.

Alternatively, in some countries you may be able to return your products to your local retailer upon the purchase of an equivalent new product.

Disposing of this product correctly will help to save valuable resources and prevent any potential negative effects on human health and the environment which could otherwise arise from inappropriate waste handling.

Please contact your local authority for further details of your nearest designated collection point.

Penalties may be applicable for incorrect disposal of this waste, in accordance with national legislation.

For business users in the European Union

If you wish to discard electrical and electronic equipment, please contact your dealer or supplier for further information.

Information on Disposal in other Countries outside the European Union

This symbol is only valid in the European Union.

If you wish to discard this product, please contact your local authorities or dealer and ask for the correct method of disposal.